

DETAIL OF MOUNTING BLOCK

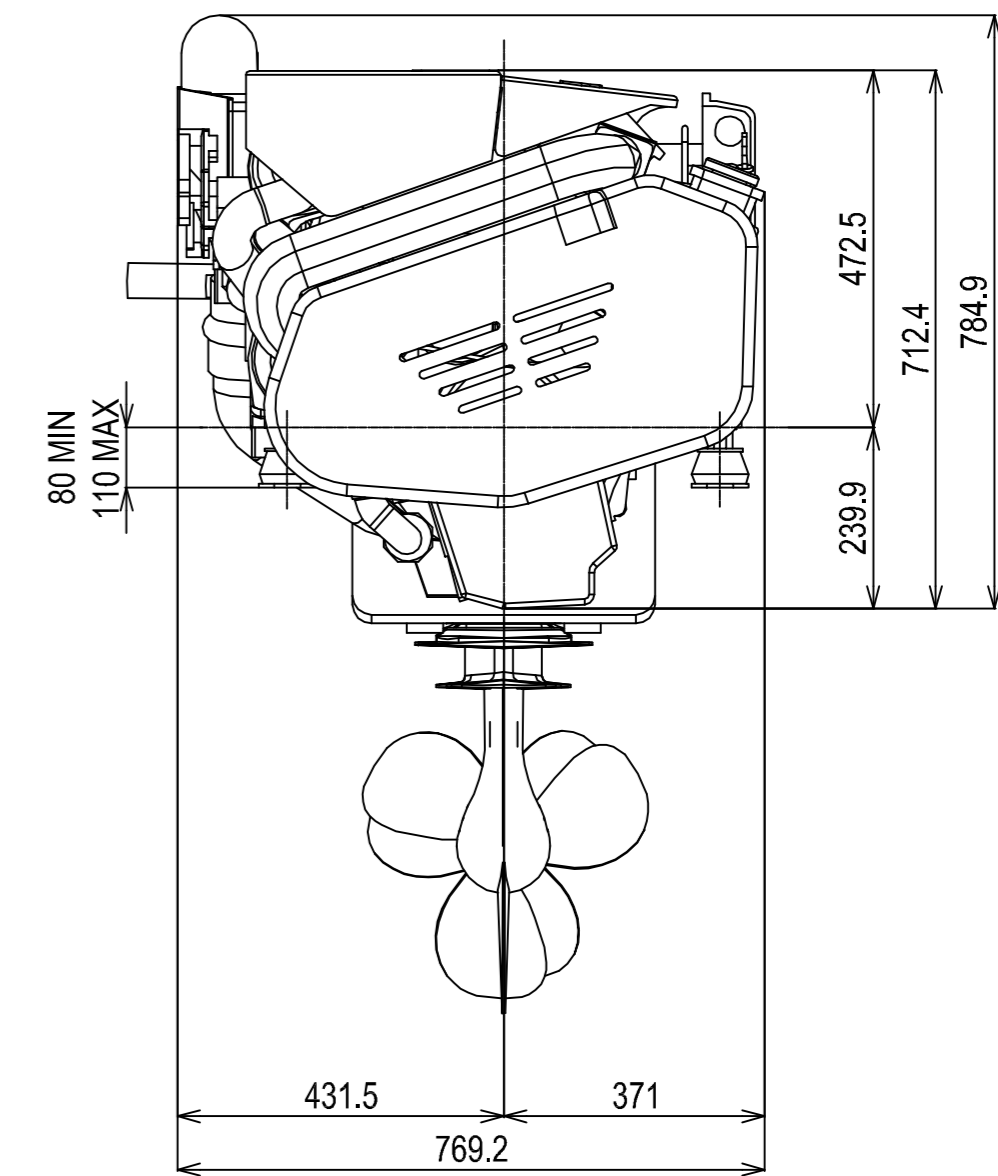
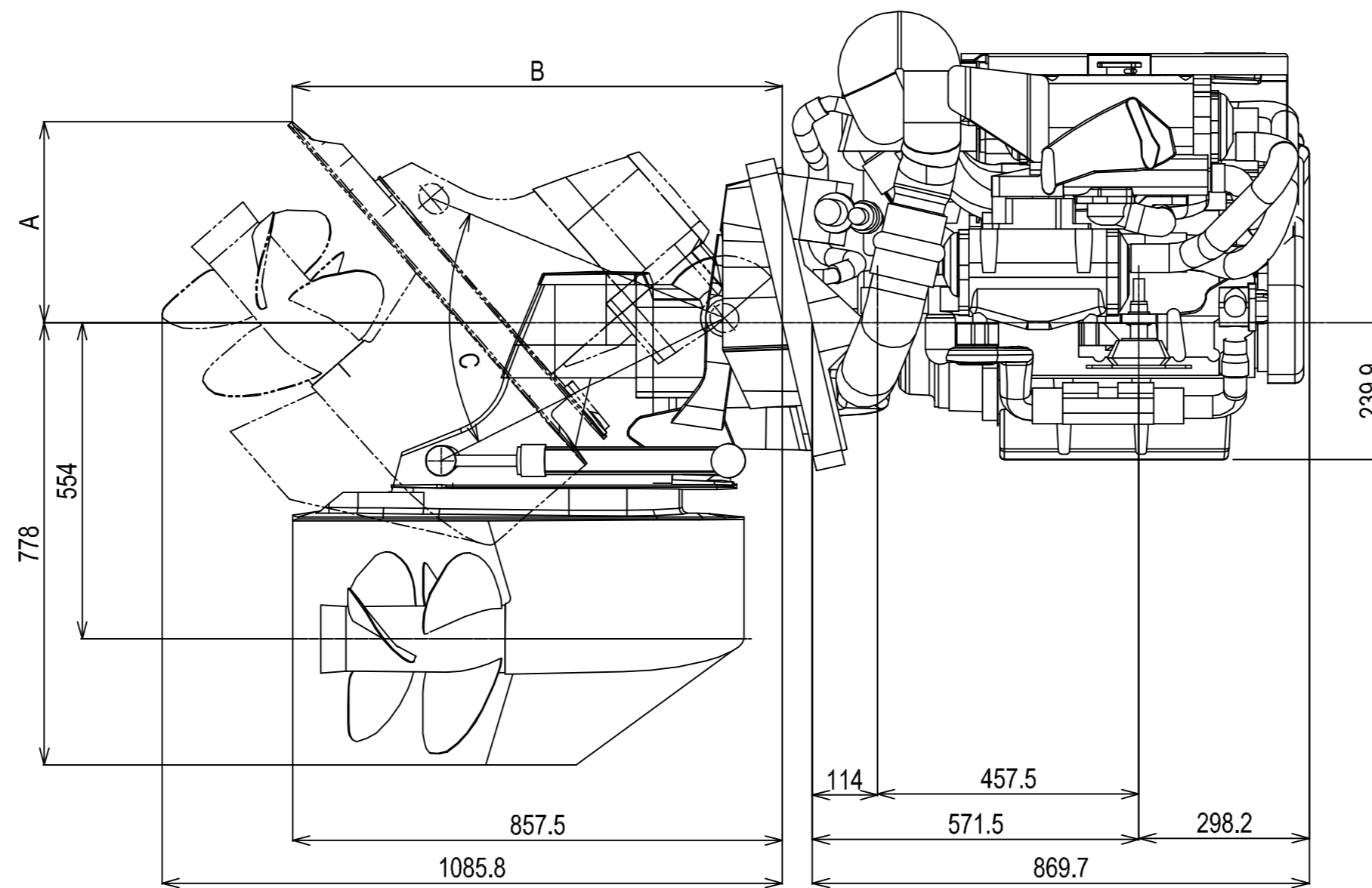
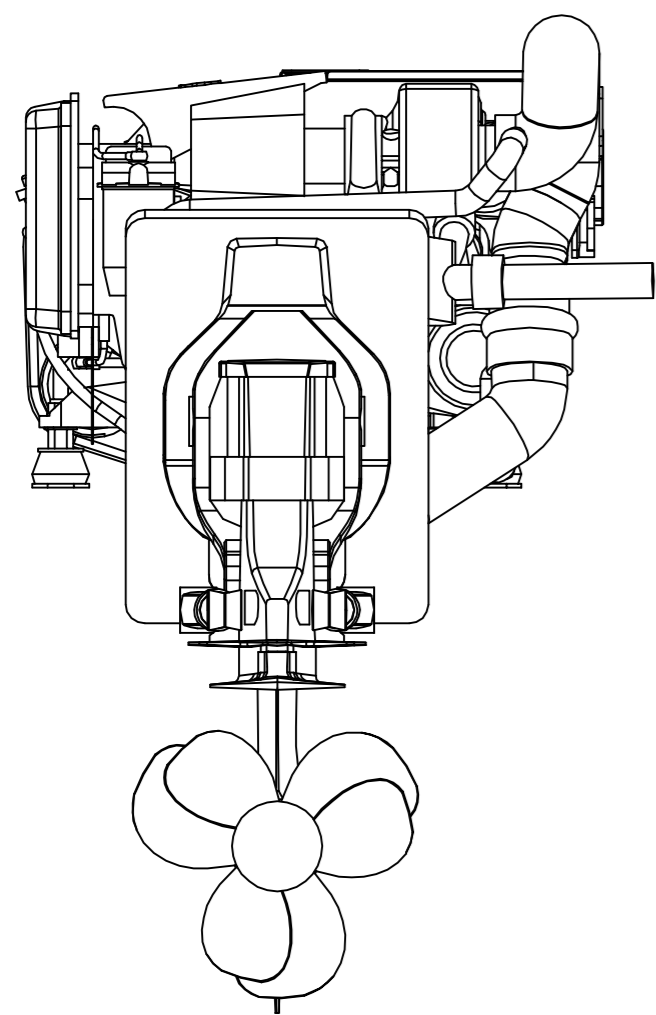
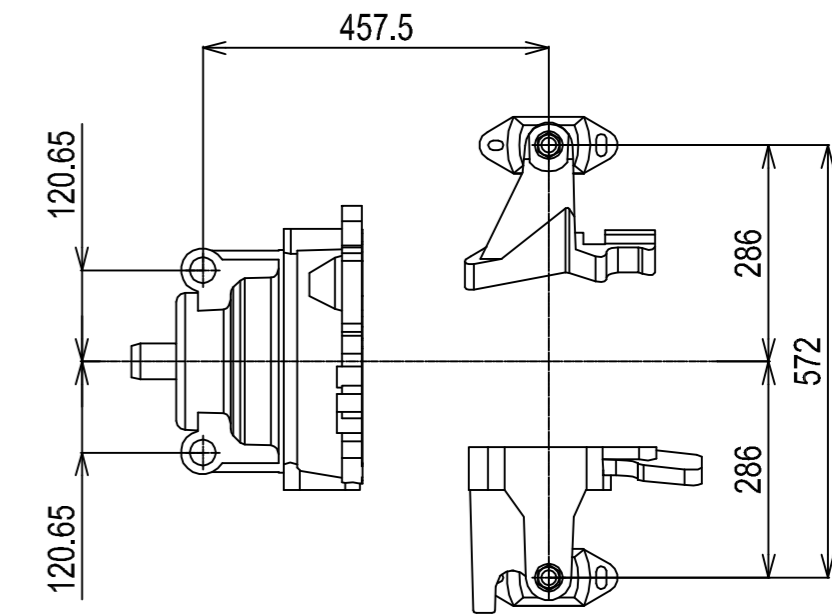
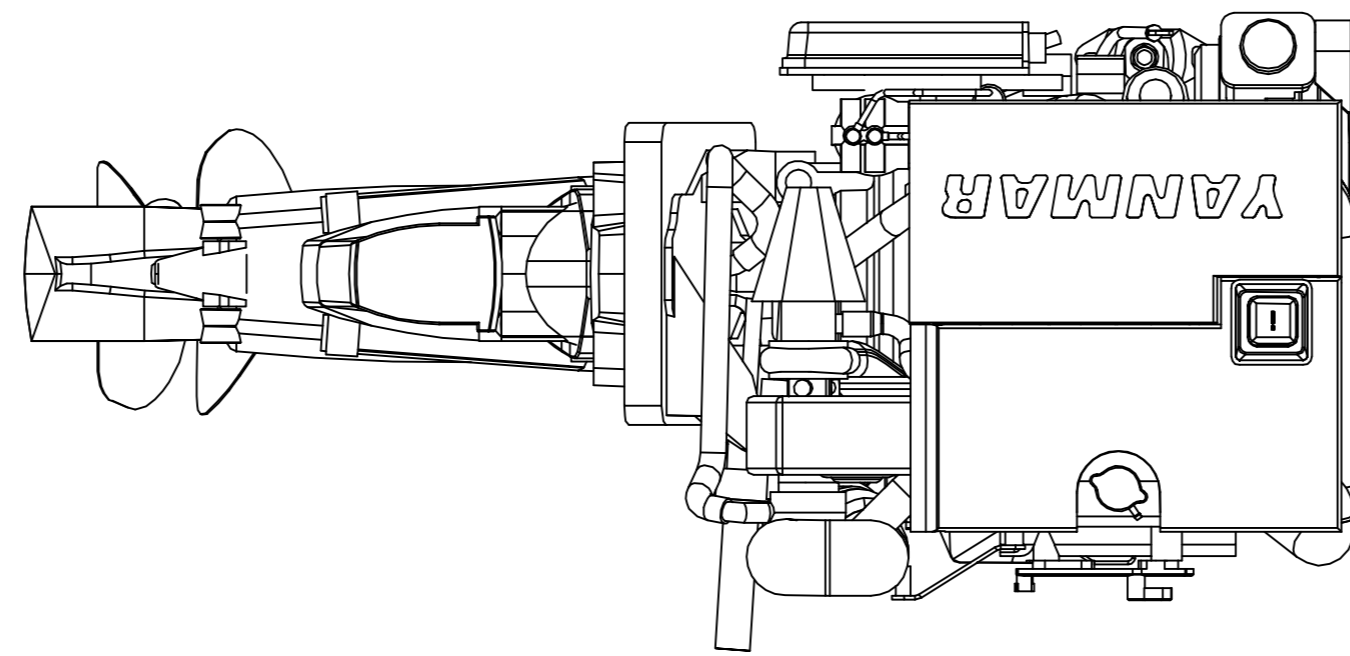
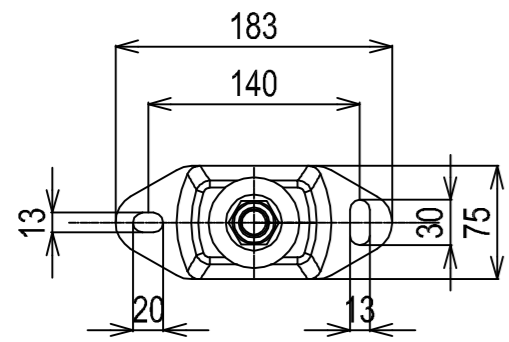

WITH TRIM-IN LIMIT INSERT IN REAR POSITION	.62" TILT-UP LIMIT SPACERS	A	B	C (MAX)
	0	375 [14-3/4]	851 [33-1/2]	51°
	1	309 [12-1/8]	880 [34-5/8]	46°
	2	278 [10-15/16]	260 [10-1/4]	41.3°

WITH TRIM-IN LIMIT INSERT IN FORWARD POSITION	.62" TILT-UP LIMIT SPACERS	A	B	C (MAX)
	0	308 [12-1/8]	880 [34-11/16]	46°
	1	277 [10-15/16]	260 [10-1/4]	41.3°
	2	263 [10-3/8]	281 [11-1/16]	36.8°

NOTE:

1. DWG. SHOWS MOUNTING BLOCKS AT ORIGINAL HEIGHT. ENGINE WEIGHT WILL COMPRESS BLOCKS BY 4MM (APPROX).
2. MOUNTING BLOCKS ARE EQUIPPED FOR STANDARD ACCESSORY.
3. ● SHOWS THE CENTER OF GRAVITY.
4. FOR ADDITIONAL INSTALLATION INFORMATION AND SPECIFICATIONS PLEASE REFER TO THE YANMAR ENGINE INSTALLATION MANUAL

Series: BY Engine: 4BY2-180Z(150Z)xBRAVO3 Release: R2008-01
 Scale: 1:10 Date: 01-10-08 Dimensions: mm

